

Auburn Gear 

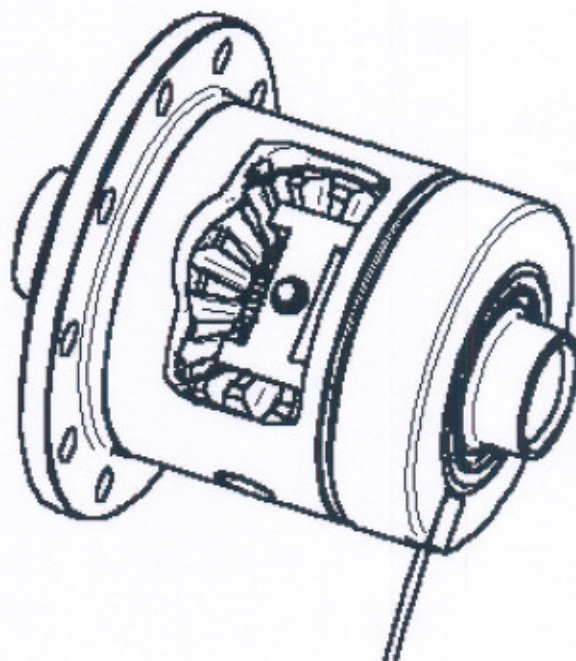

ECTEDTM

**INSTALLATION
MANUAL**

MH 567
2006-1

IMPORTANT APPLICATION NOTE

Before installing the ring gear and pressing the bearings on to the differential, the following two (2) items need to be checked:

1. Ensure that your axle shaft mates with the differential side gear. Some models have different spline counts depending on the year of manufacture.
2. Check the differential flange position (bearing shoulder to flange face) to ensure that it is correct. You may compare it to your old one. The differential flange position depends only on the gear ratio that you are using. This flange position may change at certain gear ratios. Some aftermarket ring gear and pinion sets specify the differential case "series" that is required.

If you feel that you have the wrong differential for your application, contact your **place of purchase** and make the necessary arrangements to exchange the differential for the correct one.

Once the differential has had bearings and/or a ring gear installed, it can no longer be considered new and therefore **cannot** be exchanged for a new one.

IMPORTANT LUBRICANT NOTE

The Auburn Gear ECTED design has been extensively tested with high quality **non-synthetic 80W90** hypoid oils treated with **Auburn Gear, GM or Ford friction additives** (3 oz. of additive will treat 1 quart of oil). To avoid differential clutch chatter (noise) and for optimum performance, use the oil and additive described above. **Do not use synthetic oils.**

Ford Additive: C8A219B546A

GM Additive: 1052358

Auburn Gear Additive: 504102

SPECIAL NOTES

ABS Tone Wheels

Some applications use a **Tone Wheel** for the **Anti-lock braking** system. In most instances, this Tone Wheel is fitted to the outer diameter of the ring gear flange. Remove the Tone Wheel from the original differential and install onto the new differential. Refer to vehicle service manual for detailed removal and installation procedures.

Pinion Shaft Lockscrew

The pinion shaft lockscrew must be torque down. The lockscrew is not torqued at the factory since many applications require the pinion shaft to be removed to facilitate 'C' clip installation. **Torque lockscrew to 20 - 25 lb*ft.**

ECTED Coil

The coil may become loose from the differential during shipment. This is not a defect. Reinstall the coil onto the differential and ensure that the coil rotates freely. The coil will be retained onto the differential once the tapered roller bearing cone is press onto the bearing hub.

Differential Bearings

These applications do not use the original bearings:

-GM 8.5 ~545003 & 545004 prior to 1999 ½

-Dana 35 ~545012, 13, 14 & 15

The required bearings for the above applications are:

~LM102949 bearing cone (2 required)

~LM102911 bearing cup (2 required)

Auburn Gear bearing kit **541070** contains a complete set of the bearings listed above.

SPECIAL NOTES (con't)

Axle Housing Straightness

It is important to ensure that the axle tubes are straight. Straightness can be checked visually by 'gun sighting' through the axle tube or by measuring between the left and right brake backing plate. Bent axle housings may hinder the performance of the ECTED. Make any necessary repairs before installation.

Front Axle Applications

The ECTED is not recommended for use in front axles that feature an 'Inter-Axle Disconnect'.

ECTED COIL WIRE EXIT HOLE

Determine where the coil wires will exit the axle housing. The fitting can be mounted to the axle cover through a 1/2" hole and using the supplied retaining nut. The fitting can also be screwed into a 1/4" pipe thread. If choosing this method, drill and tap the 1/4" pipe thread before installing the differential to keep debris from entering the differential. The wire exit location will be above the oil level and near the coil.



AXLE SHAFT MODIFICATIONS

Due to variations in axle shafts, certain modifications may be required to facilitate installation of the axle shaft and 'C' clip. If the axle shafts cannot be pushed in far enough to allow the 'C' clip to be installed, the following modifications may be necessary:

Axle Button Diameter:

If the button diameter on the splined end of the axle shaft is larger than 1.15", it will not be able to pass through the differential center block, hindering 'C' clip installation. Reduce the button diameter by grinding.

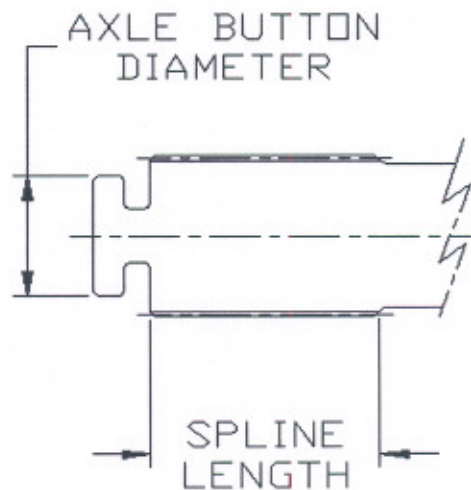

Length of Spline ('C' clip axles only):

If the length of the spline is less than 1.58" the spline may bottom out in the differential making installation of the 'C' clip impossible. **Test for fit prior to assembly.** If required, modify the spline area to achieve the proper spline length to allow the axle shaft to go further into the differential gear. **Do not** grind the side gear face to obtain additional clearance!

AXLE SHAFT MODIFICATIONS

Length of Spline (Continued)

The spline area may be modified a couple of ways to effectively increase its length to allow for 'C' clip installation. One way is to reduce the diameter behind the spline to the minor diameter of the spline as shown below.

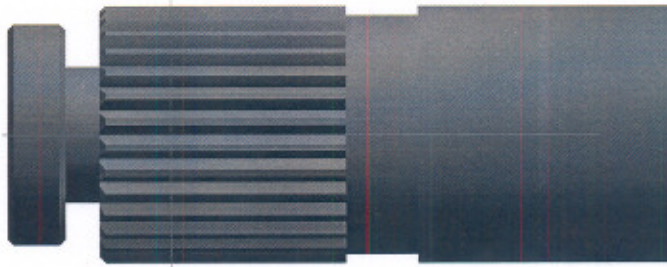

Axle shaft after modification

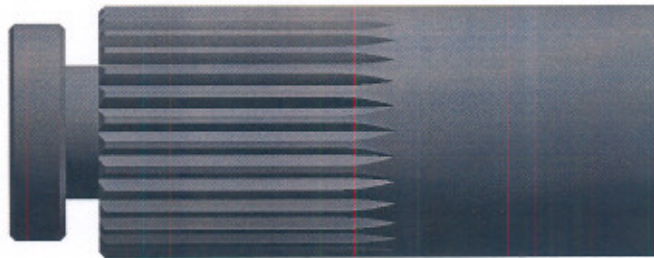

Axle Shaft before modification

Make modifications carefully as not to compromise the integrity of the axle shaft. Auburn Gear, Inc. cannot be held responsible for inappropriate modifications.

PINION SHAFT MODIFICATIONS

Some high numeric gear ratios have thick ring gears that will prevent pinion shaft removal making 'C' clip installation impossible. Some can be resolved by indexing the ring gear so that a tooth space is directly in front of the pinion shaft. It is also common practice to grind away some of the ring gear tooth to provide the necessary clearance for pinion shaft removal. If these alternatives fail, the pinion shaft must be modified.

Refer to the figure below for proper modification making note of which pinion shaft size the differential has. The screwdriver slot will provide a method of rotating the shaft into position. Remove all sharp edges after modification. **Do not** attempt to re-harden the pinion shaft.

To install the 'C' clips, rotate the pinion shaft so that the flat portion is facing the axle shaft. Push the axle shaft inward, install the 'C' clip, and pull the axle shaft outward. Repeat for the opposite shaft.

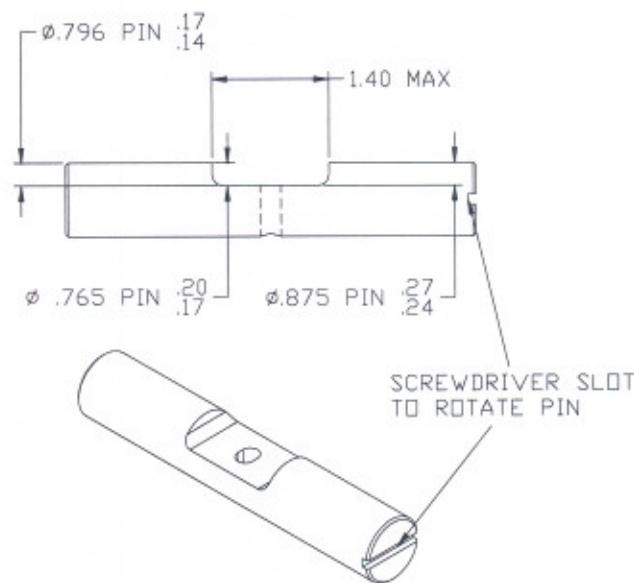

AXLE SHAFT SPACERS

Certain applications utilize an axle shaft spacer for setting the clearance for the axle shaft bearing. Some aftermarket axle bearings are configured to eliminate the axle shaft spacer. If the axle shaft spacer is required, refer to the following procedure for installation of the axle shaft spacer into the differential. The part number for the axle shaft spacer is **541050** and can be obtained from the factory.

1. Remove the differential pinion shaft lockscrew and remove the differential pinion shaft as shown.

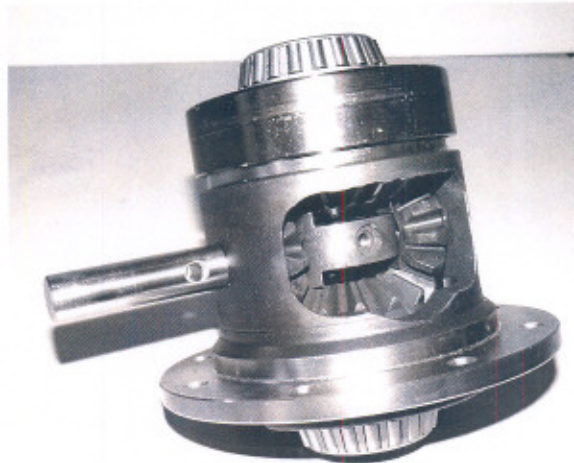

2. Partially insert the roll pin into the axle shaft spacer allowing just enough space for the pinion shaft to pass through as shown.

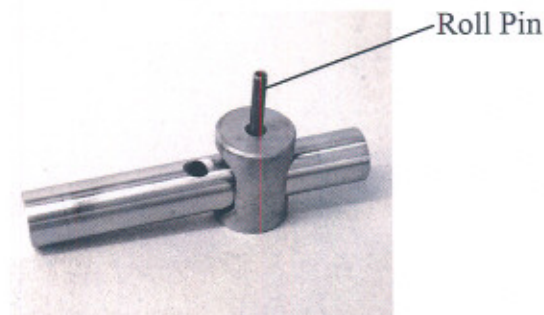

3. Partially insert the pinion shaft into the differential and insert the axle shaft spacer into the differential as shown.



4. Slide the pinion shaft through the axle shaft spacer and fully into the differential. Ensure that the hole in the pinion shaft is in line with the roll pin. Fully install the roll pin into the axle shaft spacer as shown. The roll pin will retain the pinion shaft and the lockscrew is not required.



AXLE HOUSING MODIFICATIONS

Manufacturing variations directly effect certain clearances inside the axle housing. To maintain strength, optimum performance and reliability of the ECTED, all available space has been utilized. In some instances, the axle housing may require modification to provide clearance for the ECTED. Keep modifications to a minimum while providing adequate clearance. Since the ECTED coil does not rotate, minimal clearance is required. Rotating clearances should have a minimum clearance of .020".

Paint or grease can be helpful in determining where modifications are required. Paint the suspect area of the axle housing or place grease on the coil housing/differential and install the differential into the axle housing. Install the bearing caps as well. Rotate the components to transfer witness marks onto the axle housing to show where further clearance is required.

Mask off hard to clean areas before making modifications. After performing the necessary modifications, thoroughly clean the axle housing to remove any debris.

Make modifications carefully as not to compromise the integrity of the axle housing. Auburn Gear, Inc. cannot be held responsible for inappropriate modifications.

INTRODUCTION

There are two (2) items of concern when installing a differential:

- Ring and Pinion Backlash
- Differential Carrier Bearing Preload

These items are typically adjusted by means of shims or threaded adjusters. The shims or adjusters will determine the position of the ring gear, which determines the backlash of the ring and pinion set. When installing a differential, the backlash should be set to the original backlash setting, which was measured prior to disassembly. To increase the backlash, adjust the shim packs or threaded adjusters to move the ring gear further away from the drive pinion gear. To decrease backlash, move the ring gear closer to the drive pinion gear.

Bearing preload refers to the amount of interference (press) fit of the differential case and bearings into the carrier housing. Adjust the bearing preload by adding or removing shim pack thickness or by tightening or loosening the threaded adjusters. Too much bearing preload will cause premature bearing failure. Insufficient bearing preload will allow the differential to 'walk' in the housing causing damage to the ring and pinion set and other components.

These instructions are intended as an aid for the experienced automobile mechanic in properly installing the ECTED differential. It is expected that the installer be equipped with the proper tools, equipment, and experience before attempting the installation.

It is necessary to have an extensive selection of shims or adjustable shim packs to properly install the differential. Threaded adjuster applications do not require shims.

INSTRUCTIONS

1. Raise and support vehicle.
 2. Remove wheels and brake drums or brake rotors
 3. Drain lubricant from carrier and remove cover.
 4. Remove axle shafts from housing.
 - A. 'C' clip axles
 1. Remove pinion shaft lock screw and pinion shaft.
 2. Push flanged end of axle shaft toward the center of the housing and remove the 'C' clip from the button end of the axle shaft. Repeat for other axle shaft.
 3. Remove axle shafts from housing. Be careful not to damage the oil seals.
 - B. Non-'C' clip axles
 1. Remove axle shaft bearing retaining plate nuts and remove the retaining plate.
 2. Use a slide-hammer to remove the axle shafts. Be careful not to damage the oil seals.
- Note:** Some axles use shims or adjuster nuts to set the axle shaft end play. Refer to the vehicle service manual for the proper removal and installation procedures for the axle shafts.
5. For removable carriers, disconnect the drive shaft from the pinion yoke and remove the third member from the axle housing.

6. Prior to further disassembly, measure and record the ring and pinion backlash. Mount an indicator as shown. Hold the drive pinion stationary and rotate the ring gear in both directions to measure the amount of backlash or free play. Check the backlash at three to four points around the ring gear and record for later use.

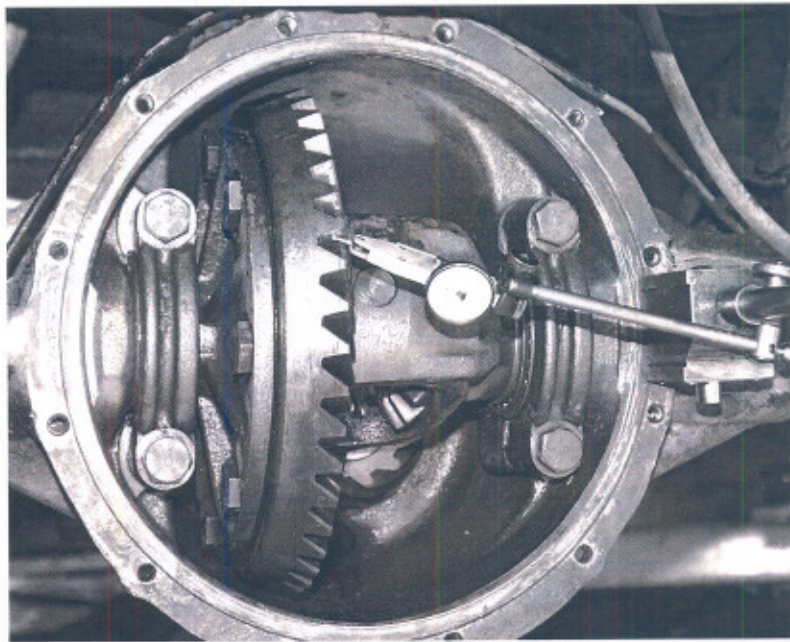

7. Mark bearing caps "R" and "L" to make sure that they will be reassembled in their original position.

8. If equipped with adjuster nuts, remove adjuster nut locks and loosen adjuster nuts. Refer to service manual for proper tool.

9. Remove bearing cap bolts and bearing caps.

10. Remove differential case. It may be necessary to use a pry bar as shown below. Exercise caution when prying on the carrier so that the gasket sealing surface is not damaged. Place shims/adjuster nuts and bearing cups with their respective bearing cap.

Note: Adjuster nuts will stay in the housing in some axles.

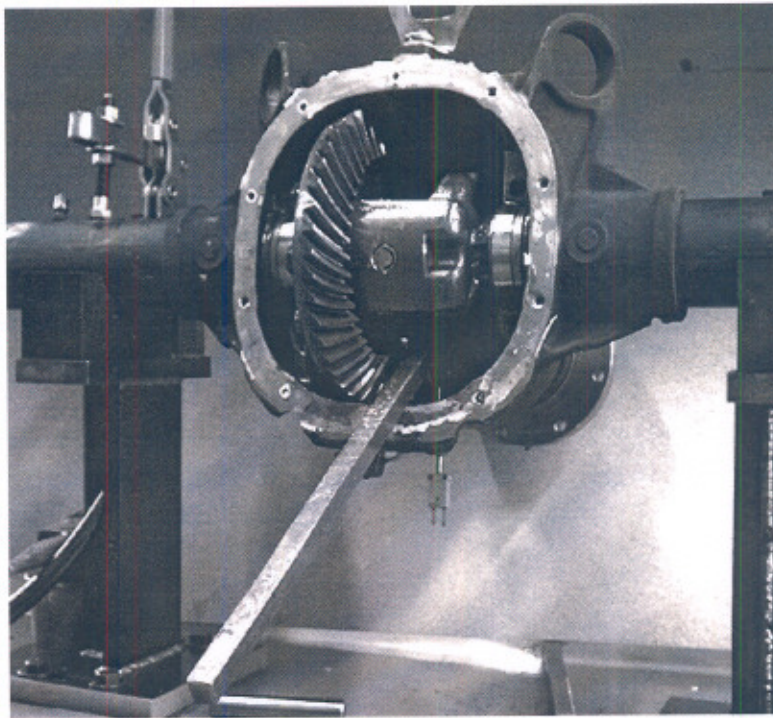

11. Remove and discard the ring gear bolts. With a non-metallic hammer or brass drift punch, drive the ring gear loose from the differential case pilot and remove.

12. Remove anti-lock brake tone wheel if applicable. Consult vehicle service manual for proper procedure.

13. Remove differential bearing cones from the differential using the proper bearing puller and adapter as shown.

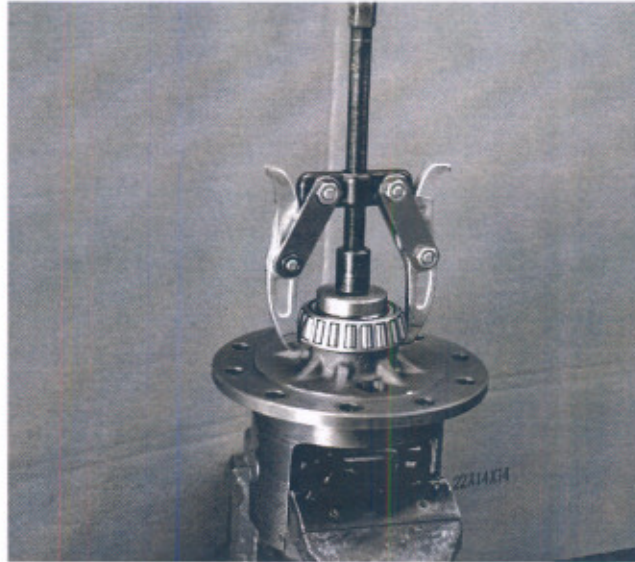

14. Clean all parts in a suitable cleaning solvent and dry thoroughly. Clean axle housing by pushing a clean rag through the axle tube with a wooden rod. Push the rag from the end of the axle tube to the center of the axle housing. Wipe down the inside of the housing with a clean rag.

CAUTION: Do not spin-dry the bearings with compressed air. Serious injury may result.

15. Remove any burrs from all machined surfaces in the axle housing, bearing cap and ring gear.

16. Inspect axle shaft bearing surface, bearings and seals. Replace if needed.

17. Inspect differential bearings and replace if needed. Always replace both the cup and cone as a set from the same manufacturer.

18. Thoroughly clean the differential bearing hubs and ring gear mounting flange prior to installation of the bearings and ring gear.

19. Install the differential bearing cones onto the bearing hubs of the differential case using the proper installation tool as shown. The inner race of the bearing cone will retain the coil bearing onto the differential.

Note: Some applications use shims between the bearing cone and the differential case bearing hub shoulder. The bearing cones must be removed to make adjustments to the shim pack thickness. Use of set-up bearings (bored out bearing cones) are required to determine the required thickness of the shims. The coil housing makes it very difficult to remove a pressed on bearing without destroying the bearing. **Use set-up bearings to determine the required shim thickness!**

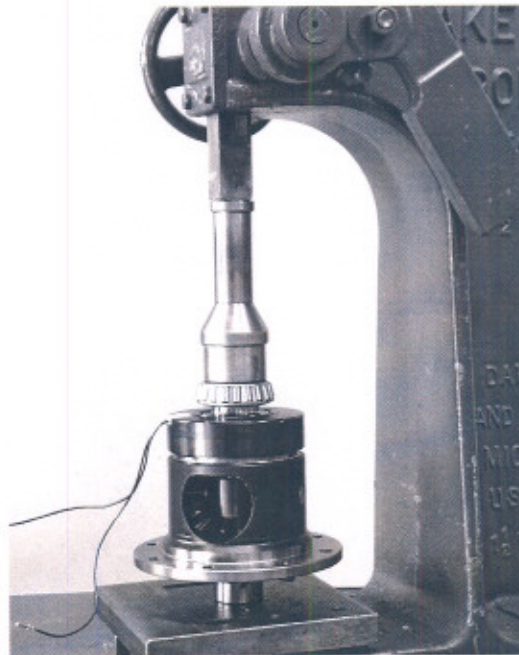

20. For adjuster nuts, skip to Step 23.
21. Install differential with the bearing cups and shims into the differential housing. Adjust the shim pack as necessary to create a slip fit of the differential into the differential housing. A slip fit is the thickest shim pack that can be installed by hand with slight resistance. It will be necessary to rotate the differential case after each shim thickness change to seat the bearings.
22. Remove the differential from the differential housing. Measure the combined thickness of the shims. This total shim thickness is what is needed for installing the differential (prior to adding preload to the bearings).
23. Heat the ring gear and anti-lock tone wheel (if applicable) with a heat lamp or by submersing in hot water. Do not exceed 300° F. **Do not use a torch!**
24. Install anti-lock tone wheel (if applicable) while hot onto the outside diameter of the differential ring gear flange as stated in the vehicle service manual.
25. Install the ring gear while hot onto the differential. It is advantageous to use pilot studs to align the ring gear to the differential as shown.



26. Using new ring gear bolts, alternately tighten each ring gear bolt to the proper torque. Consult service manual for proper torque values.

3/8" Bolts ~ 50 lb ft

7/16" Bolts ~ 80 lb ft

1/2 " Bolts ~ 100 lb ft

27. For adjuster nuts, skip to Step 35.

28. Select two shims of approximately equal size whose total thickness is equal to the shim pack thickness determined in step 22.

29. Place the differential assembly with the ring gear, bearing caps and shims into the differential housing. Install bearing caps and bolts in their proper position and tighten bolts. While tightening bearing cap bolts, continuously rock the ring gear back and forth to confirm backlash. If at any time the backlash becomes reduced to zero, remove bearing caps and adjust the shim packs by removing .010" from the ring gear side and adding .010" to the opposite side. Repeat as needed until both bearing caps can be torqued to the proper torque value and ring and pinion backlash is confirmed.

30. Rotate the differential case several revolutions to seat the bearings. Check the backlash as described in Step 6.

31. Compare the backlash reading to the original reading taken in Step 6 and adjust as needed. To increase backlash, remove shim thickness from the ring gear side and add an equal amount of shim thickness to the opposite side. To decrease backlash, add shim thickness to the ring gear side and remove an equal amount of shim thickness from the opposite side.

Note: approximately .001" of shim equals .001" of backlash.

32. Once the correct backlash reading has been established, add .004" of shim thickness to both shim packs to preload the differential bearings. It will be necessary to drive the shims and/or differential into position. Do not strike the bearing cups. It is advantageous to use a **Case Spreader** to install the differential.
33. Torque the bearing cap bolts to the proper value and rotate the differential case several revolutions to seat the bearings. Recheck the backlash and correct if necessary.
34. Skip to Step 43.
35. Place the differential assembly with ring gear and bearing cups into the differential carrier.
36. Apply a light coat of axle oil to the bearings and adjuster nut threads.
37. Install the bearing caps in their original position and hand tighten the bearing cap bolts.
38. Install the adjuster nuts (unless still in the differential housing) being careful not to cross thread the adjuster nuts causing thread damage.
39. With the adjuster nuts installed and the bearings in position, torque the bearing cap bolts to the proper torque value.
40. Loosen the RH adjuster nut (opposite the ring gear) until it is away from the bearing cup. Tighten the LH adjuster nut (ring gear side) until the ring gear is slightly forced into the drive pinion (zero backlash). Rotate the differential several revolutions to ensure no binding is present. Recheck RH adjuster nut to be sure that it is not against the RH bearing cup. Use an appropriate tool to turn adjuster nuts.

41. Install indicator as shown in Figure 6. Tighten RH adjuster nut until a case spread of .008 - .012 is measured. Rotate drive pinion several times in each direction to seat the bearings and to be sure that binding does not occur. It may be necessary to readjust the case spread by tightening the RH adjuster nut.

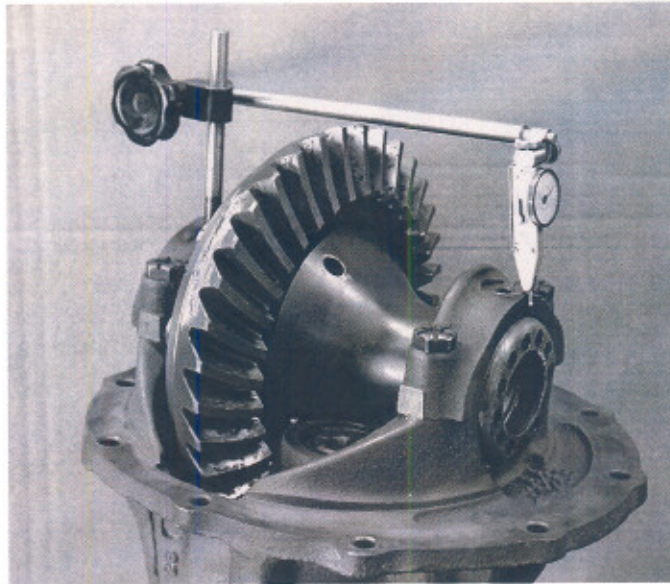

42. Measure the backlash as done in Step 6. If necessary, adjust the backlash until it matches the original reading taken in Step 6. Increase backlash by loosening the LH adjuster and tightening the RH adjuster the same amount. Decrease backlash by loosening the RH adjuster nut and tightening the LH adjuster nut the same amount. When making adjustments, always make the final adjustment in the tightening direction. For example, if an adjuster needs to be loosened one notch, loosen it two notches and tighten it one. When the proper backlash has been established, install the adjuster nut locks.

43. Install axle shafts and 'C' clips (if applicable). Insert differential pinion shaft.

44. **Torque lockscrew to 20 - 25 lb*ft**

45. Remove lower right hand bearing cap bolt and install appropriate coil retainer and re-torque bolt to specification. Be sure that the coil retainer does not cause the coil to bind. The coil should have some slight rotational play.

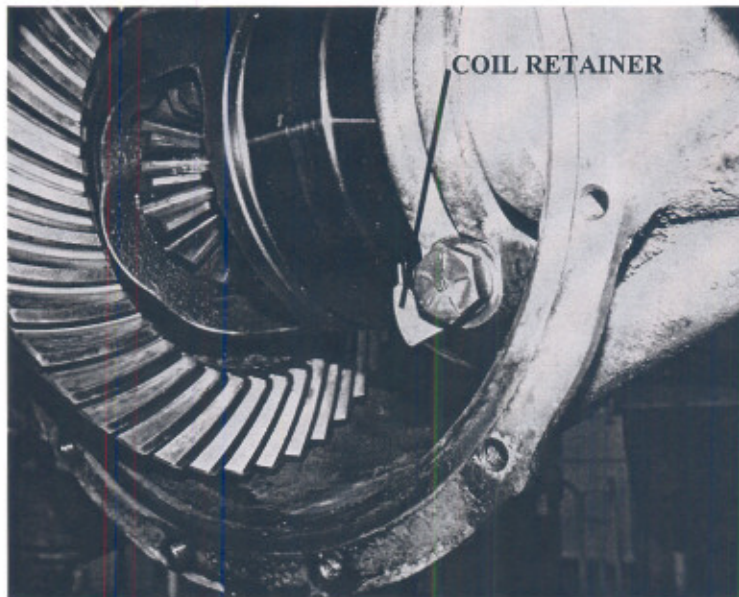

Note: Check for rotational play of the coil prior to installing the coil retainer. If there is evidence of rotational drag or binding, the axle housing may need modified to provide clearance for the coil. See **Page 9** for further instruction.

46. Disassemble the wire fitting by removing the dome nut and removing the bushing assembly. Remove the bushing from the bushing retainer and replace it with the supplied two-hole bushing as shown.

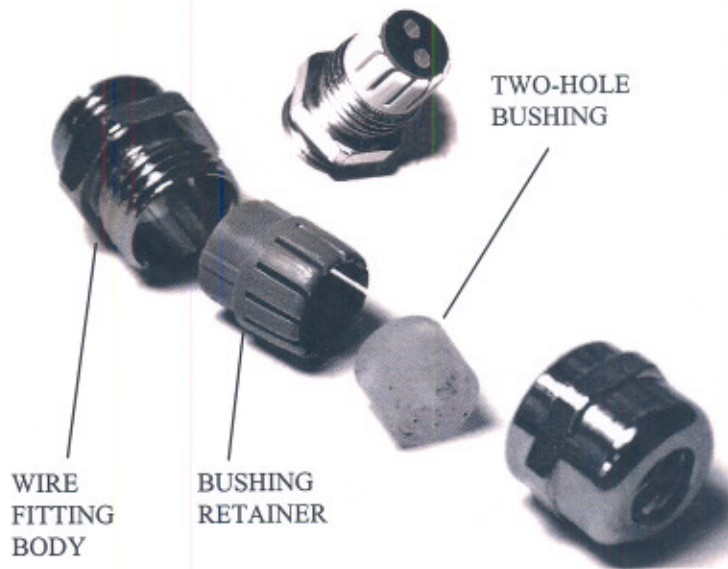

47. Install the wire fitting body onto the axle housing or axle housing cover. If installing onto the housing cover, use the supplied retaining nut.

48. Insert the coil wires through the wire fitting body.



49. Insert the coil wires into the bushing assembly.



50. Insert the bushing assembly into the wire fitting body and install the dome nut and tighten. Be certain that the coil wires are clear of rotating parts inside the axle housing.

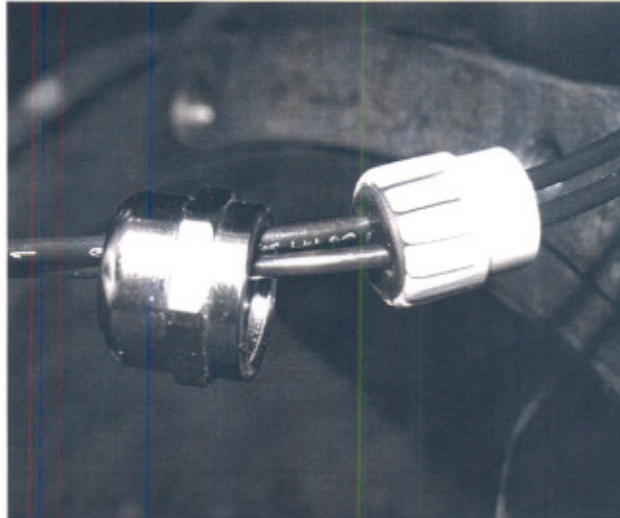

51. Install the axle cover and tighten cover bolts.

52. Fill axle to appropriate level with 80W90 non-synthetic lubricant and supplied additive. Use 3 oz. of additive per quart of lubricant.

53. Insert the coil wire leads into the plug body. The leads will 'snap' into position.

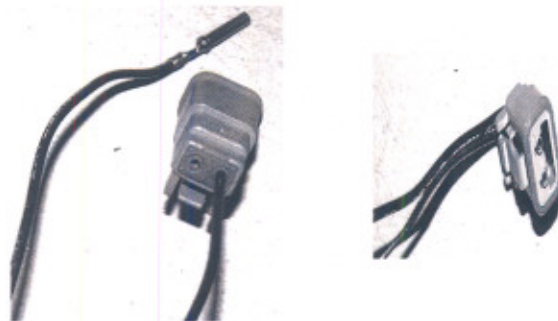

54. Once the coil leads are fully inserted into the plug body, install the wedge-lock to secure the coil leads.

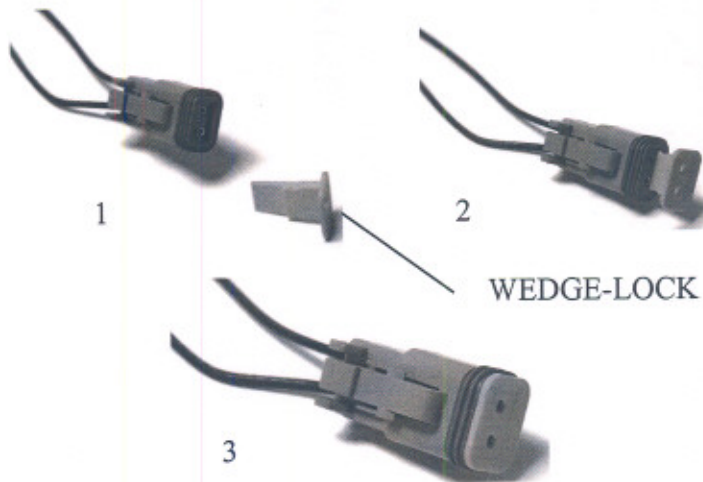

55. Install the wire loom between the plug body and wire fitting. It may be necessary to cut the loom to the proper length. Secure the ends with a wire tie or tape.



56. Connect coil wire plug assembly to supply wire plug.

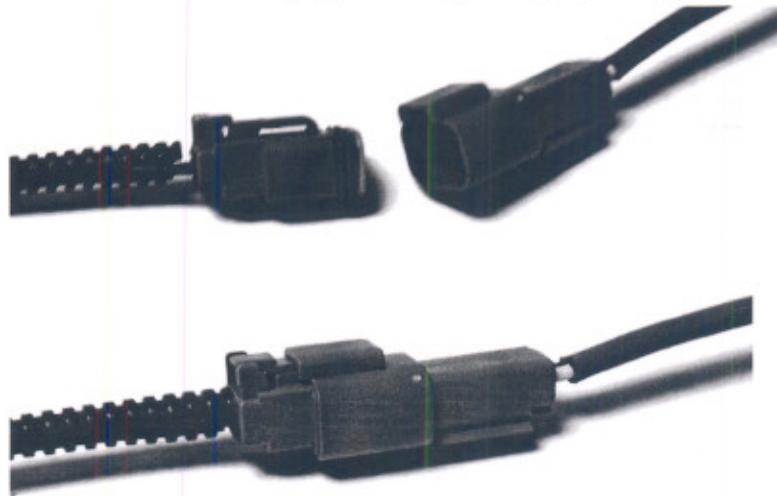

57. Beginning at the plug end, route the supply wire along the axle housing to the frame. Following a brake line, service brake cable, or housing vent tube will protect the wire and allow for suspension articulation. Secure the supply wire with wire ties.

58. Route the supply wire into the vehicle's interior and to the switch location avoiding sharp edges which may damage the wire insulation. Choose a switch location that is easily accessed and not subject to accidental activation.

59. The supplied switch is easily capable of handling the current draw of the ECTED. When connected correctly, the LED will illuminate when the differential is engaged. There are three (3) numbered terminals on the back of the switch.

Terminal #2: Connect to positive power supply

Terminal #3: Connect to ECTED coil lead

Terminal #7: Connect to clean chassis ground

ELECTRICAL CONNECTIONS

To complete the wiring, refer to the following schematic. The ECTED coil has no polarity requirement. Connect one lead to the switch and the other lead to a clean chassis ground.

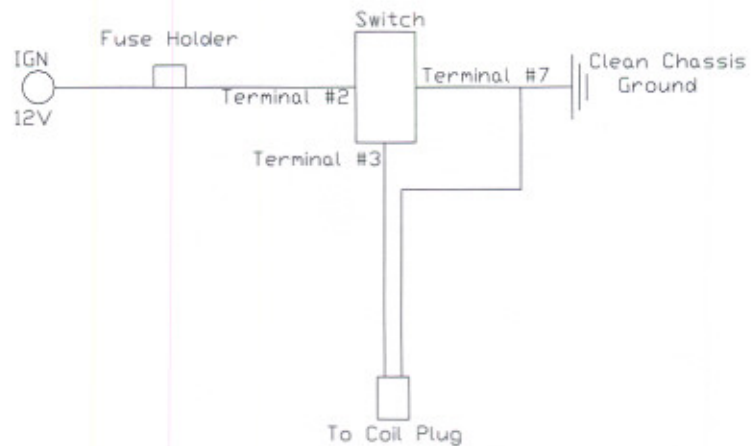

Included with the wiring kit are fuse taps, female terminal ends, butt connectors, stud terminal, fuses and fuse holder, primary wire and wire ties.

Switch Cut-Out Template

.95" Width

1.88" Height

ELECTRICAL CONNECTIONS

1. Connect the power cable to the switch (insulated push-on connector) at terminal #3 and ground the switch (black wire with ring terminal) and power cable (ring terminal) to a suitable ground.
2. Locate a suitable 12 volt DC **ignition** power source at the fuse block. The source should be capable of 10 amps. **Do Not** use a non-ignition power source.
3. Remove the fuse and install a suitable fuse box tap to the fuse and reinstall the fuse.
4. Insert a 10 amp fuse into the in-line fuse holder and attach to the fuse box tap using an insulated push-on connector.
5. Attach the red power cable to the switch at terminal #2 using the insulated push-on connector.
6. Trim the power cable to a suitable length if required and attach to the remaining lead of the in-line fuse holder with an insulated butt splice.

NOTE: It is very important that the electrical system is supplying the proper voltage to the coil. A minimum of 12 volts DC is required for proper engagement function. Voltage should not exceed 16 volts DC.

ECTED OPERATION

The ECTED operates as a limited-slip differential until activated. Once activated, the differential becomes locked until deactivated. To activate the ECTED, simply flip the switch. A green light indicates that the ECTED is activated.

Since the ECTED is wired to an ignition power source, shutting the vehicle off will deactivate the differential.

The ECTED may be activated while the vehicle is in motion, even if one wheel is spinning. However, dynamic engagements can create shock loading to the drivetrain and cause damage. To prevent this, limit the speed of dynamic engagements (one wheel spinning) to below 5 MPH.

Engaging the ECTED before encountering a traction demanding situation is advisable. It is also recommended that the ECTED be disengaged on high traction surfaces during turning maneuvers to prevent unnecessary stress on the drivetrain components.

Use caution when operating on low traction surfaces. High speeds on slippery surfaces with a locked differential can cause loss of vehicle control. Drive carefully and slowly.

DISENGAGEMENT

During disengagement, any residual torque build up in the axle shafts will be released. This sudden torque release may cause a 'clunk' sound, which is normal.

It may be necessary to create a torque reversal to disengage the differential. To create a torque reversal, simply turn to the left for approximately 15 feet and then turn to the right for approximately 15 feet. If the differential remains engaged, repeat procedure on a higher traction surface. Gradual turns are more effective than full-lock turns.

**AUBURN GEAR, INC.
PERFORMANCE DIFFERENTIAL
LIMITED WARRANTY AND REMEDY**

LIMITED WARRANTY

Auburn Gear, Inc. ("Manufacturer") warrants that this product is free from defects in materials and workmanship for a period of one (1) year after purchase by the consumer, or 12,000 miles of normal use by the consumer, whichever is less; provided that this product:

has been installed and maintained in accordance with the Manufacturer's instructions; and

has been used in regular automotive driving and not in any off-road application; and

has been used with the proper lubricant and additive, as specified in the installation instructions at all times; and

has not been subject to modification, accident, or misuse.

This limited warranty is the sole express warranty provided by manufacturer to the ultimate user of the product. The manufacturer disclaims all other express warranties, and all implied warranties, including the implied warranties of merchantability and fitness for a particular purpose.

EXCLUSIVE REMEDY

In the event of a breach of this warranty, you shall return the product to the seller within thirty (30) days after the expiration of the limited warranty period, along with your proof of purchase and explanation of the defect. Seller or Manufacturer may investigate the claim of defect, and in the event of a defect in the product shall, at their election, either repair the defective product, replace the defective product with a new product, or refund the purchase price. These remedies are your sole and exclusive remedies in the event of a breach of warranty.

LIMITATION OF LIABILITY FOR DAMAGES

In no event shall Manufacturer be liable for consequential, special, indirect, or exemplary damages, whether based upon tort, contract, warranty, negligence, strict liability, or other legal theory. Manufacturer's liability shall be limited to direct damages.

EXCEPTIONS TO LIMITED WARRANTY AND REMEDY

This limited warranty and remedy gives you specific legal rights. You may have other statutory rights in states that do not allow the limitation on or exclusion of certain warranties or remedies.